



MEGAWALL[®]
SLATWALL SYSTEMS

1-800-948-2736
www.megawall.com

Specified by World Class Designers for Leading Retailers

Beautiful and durable with unparalleled strength.



Steel

The #1 specified steel slatwall.

Outstanding appearance, incredible strength and unmatched durability. Specified by world class designers for leading retailers, Megawall steel slatwall is unmatched in value. Available in an exciting variety of finishes that can be mixed and matched on the same wall or fixture. Custom colors too — just call!

MegaWall steel slatwall installs easily and quickly with no visible fasteners. It's available in custom lengths, has no dust or formaldehyde emission, no expansion or shrinkage issues and is easy to clean.

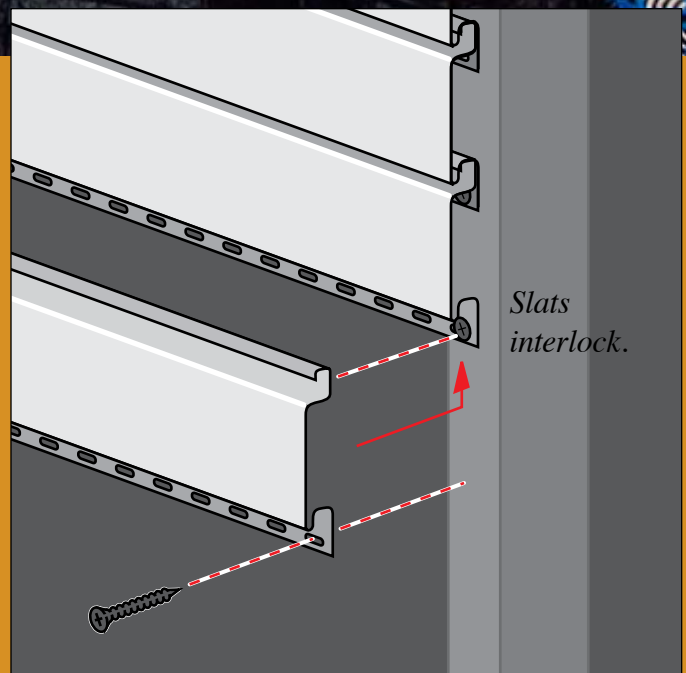

Steel Slatwall Specifications

3" On-Center Steel Slatwall

Part # (96" wide)	Part # (48" wide)	Color	Price
P-3-96-257	P-3-48-257	Beige	\$229
P-3-96-112	P-3-48-112	White	\$229
P-3-96-114	P-3-48-114	Grey	\$229
P-3-96-111	P-3-48-111	Black	\$229
P-3-96-131	P-3-48-131	Clear On Steel	\$229
P-3-96-303	P-3-48-303	Bright Galvanized	\$229
P-3-96-500	P-3-48-500	Platinum	\$259
P-3-96-501	P-3-48-501	Clear On Brushed	\$289
P-3-96-505	P-3-48-505	Clear On Swirl	\$289
P-3-96-175	P-3-48-175	Candy Apple Red	\$289
P-3-96-234	P-3-48-234	Candy Apple Blue	\$289

Each slatwall box contains slats that interlock to create 32 square feet of slatwall. Choose between 4' x 8' or 8' x 4'.

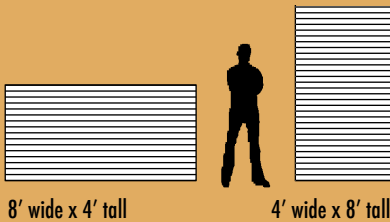

MegaWall Steel Slatwall meets ASTM E-84-91A flame test standards with ratings of 5 for flame spread and 0 for smoke development.

Standard Colors



MegaWall can custom match most colors. Call us.

Slatwall Finishing Trim & Corner Options

Trim Style	Part #	Price
End Trim	T-L-96	\$21.50
90 Degree Outside Trim	T-O-90	\$23.50
90 Degree Inside Trim	T-I-90	\$23.50
Top Trim	T-T-96	\$25.00
Bottom Trim	B-T-96	\$21.50
45 Degree Outside Trim	T-O-45	\$23.50
45 Degree Inside Trim	T-I-45	\$23.00

Trim comes in Anodize, Beige, White, Black, Galvanized and Grey finishes.

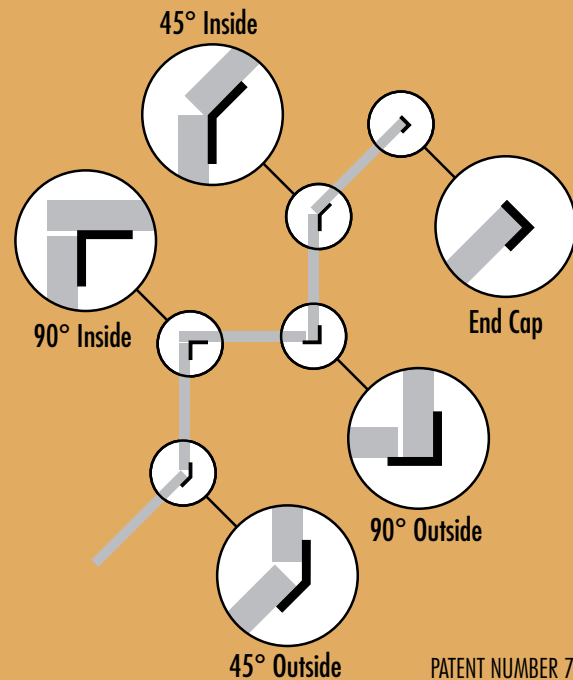

PATENT NUMBER 7,571,571 B1

The most versatile slatwall available. Period.

Aluminum

Lightweight, multiple slat options & finishes

MegaWall aluminum slatwall offers outstanding advantages for use on walls and in fixtures. It comes in both anodized and powdercoat finishes and is LEED certified. Available in 4 different slat spacings — 1", 1.5", 2" and 3" on-center to suit any display environment. The 1" and 1.5" versions have options of a flat back, hidden-fastener back (no visible screws) or even double sided — ideal for freestanding displays. Our 2" works as single or double-sided and our 3" is available only as a hidden fastener. All extrusions come as 6" high sections that interlock together. Custom lengths and colors are available - just call for a quote.

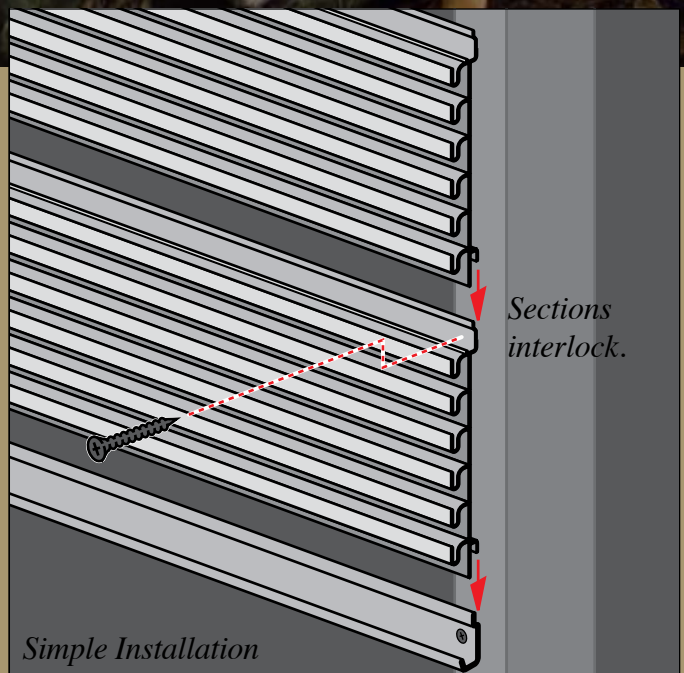

Aluminum Slatwall Specifications

We can custom powdercoat match most colors. Setup charges and minimum runs may apply. CAD files are available on request. Standard products and finishes usually ship in 1-2 weeks. All orders are shipped bulk, common carrier unless other arrangements are made.

Standard Colors



000 Raw Mill



111 Black



800 Clear Anodize



112 White

1" On-Center, 6" High Extrusion

Part #	Description	Raw Mill	Anod./Paint
A10-1S-96	Flat Back, 96" long	\$31.00	\$39.50
AHF-1-96	Hidden Fastener - No Visible Screw, 96" long	\$37.00	\$46.00
A10-2S-96	Double Sided, 96" long	\$57.50	\$75.00

Single Sided

Hidden Fastener

Double Sided

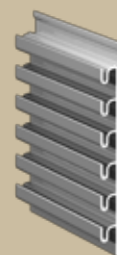

1.5" On-Center, 6" High Extrusion

Part #	Description	Raw Mill	Anod./Paint
A15-1S-96	Flat Back, 96" long	\$31.00	\$39.50
AHF-15-96	Hidden Fastener - No Visible Screw, 96" long	\$37.00	\$46.00
A15-2S-96	Double Sided, 96" long	\$57.50	\$75.00

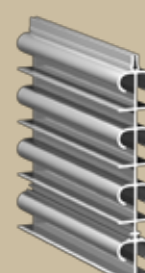
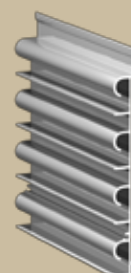
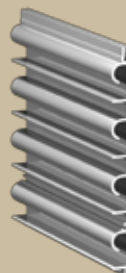

2" On-Center, 6" High Extrusion

Part #	Description	Raw Mill	Anod./Paint
AHF-2S-96	Double Sided, 96" long	\$31.00	\$39.50

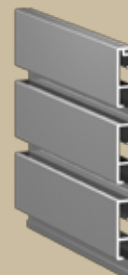

3" On-Center, 6" High Extrusion

Part #	Description	Raw Mill	Anod./Paint
AHF-3-96	Hidden Fastener - No Visible Screw, 96" long	\$27.00	\$36.50



J-Cap for All Hidden Fastener Extrusions

Part #	Description	Raw Mill	Anod./Paint
AHF-JC-96	Start/Finish Strip for Hidden Fastener, 96" long	\$8.50	\$11.00

Serves for both top and bottom trim

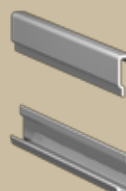

PATENT NUMBER 6,349,507

MEGAWALL
SLATWALL SYSTEMS

800-948-2736 www.megawall.com

Lightweight with multiple slat spacing.

Plastic

Bendable and ideal for lightweight fixtures

MegaWall plastic slatwall can be specified for both perimeter walls and retail fixtures. It's most unique quality is that it can be bent around curves or even columns. Light in weight, it's also ideal for counter top displays. As a final plus, it's 100% recyclable. Available only in flatback style. Standard colors are white and black. Custom colors can be quoted.



Plastic Slatwall Specifications

1-3/8" On-Center, 8.75" Extrusion

Part #	Description	Unit Price
NL-96-W	Narrowline PVC, 8.75" Tall Extrusion 96" Long	\$39.50
NLP_*x_*	Narrowline PVC Panel, 4'x8' or 8'x4' with Luan back	\$310.50

Both 1-3/8" and 1" are available in stock white and black. Panels come standard with 1/4" luan backer which can be substituted with Sintra or 3/8" plywood for additional cost.

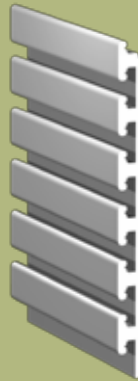
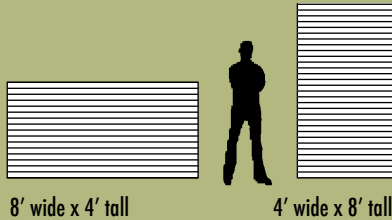

Plastic bends around curves and even columns.

1" On-Center, 6" Extrusion

Part #	Description	Unit Price
AP-1-96-W	MegaWall Rigid Styrene 6" Tall Extrusion 96" Long	\$28.00

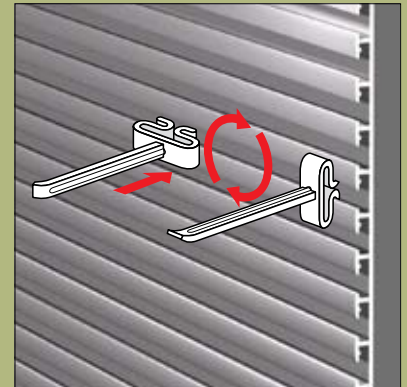

Our 1" plastic slatwall accomodates custom hooks that snap in, twist and lock securely - even on displays that spin. They're ideal for earrings and jewelry like items. For lightweight use only.

High Performance Steel Shelves — Mega-Strong!

Shelves, Brackets

The strength of MegaWall meets it's Full Potential.

High Performance Shelves

Part #	Dimensions	Unit Price
HPS-1818-6	18" Wide x 18" Deep	\$98.00
HPS-2314-6	23" Wide x 14" Deep	\$98.00
HPS-2422-6	24" Wide x 22" Deep	\$109.00
HPS-3414-6	34" Wide x 14" Deep	\$109.00
HPS-4614-6	46" Wide x 14" Deep	\$121.00
HPS-4824-6	48" Wide x 24" Deep	\$144.00

Medium Performance Shelves

Part #	Dimensions	Unit Price
MPS-2412-3	24" Wide x 12" Deep	\$65.00
MPS-3612-3	36" Wide x 12" Deep	\$75.00
MPS-4812-3	48" Wide x 12" Deep	\$85.00

Custom sizes available. Shelf brackets too.



Medium Performance Shelf

Panels. Ready made and ready to work.



48" x 12"



48" x 24"



24" x 24"



24" x 48"



12" x 48"



24" x 55" w/12" Deck

Panels



Install the hanger and hang the panel. Easy!



Aluminum Wall Panels

Part #	Dimensions	All Finishes
4812P-1	48" Wide x 12" High	\$150.00
4824P-1	48" Wide x 24" High	\$225.00
2424P-1	24" Wide x 24" High	\$170.00
2448P-1	24" Wide x 48" High	\$225.00
1248P-1	12" Wide x 48" High	\$150.00
TS2448-1	24" Wide x 55" High, 12" Deck	\$485.00

MegaWall panels are a great looking, durable and easy solution to many slatwall needs. All panels include hidden hanger strips for easy, simple and quick installation.

MEGAWALL®
SLATWALL SYSTEMS

800-948-2736 www.megawall.com

Retrofit any gondola. It's easy and quick.

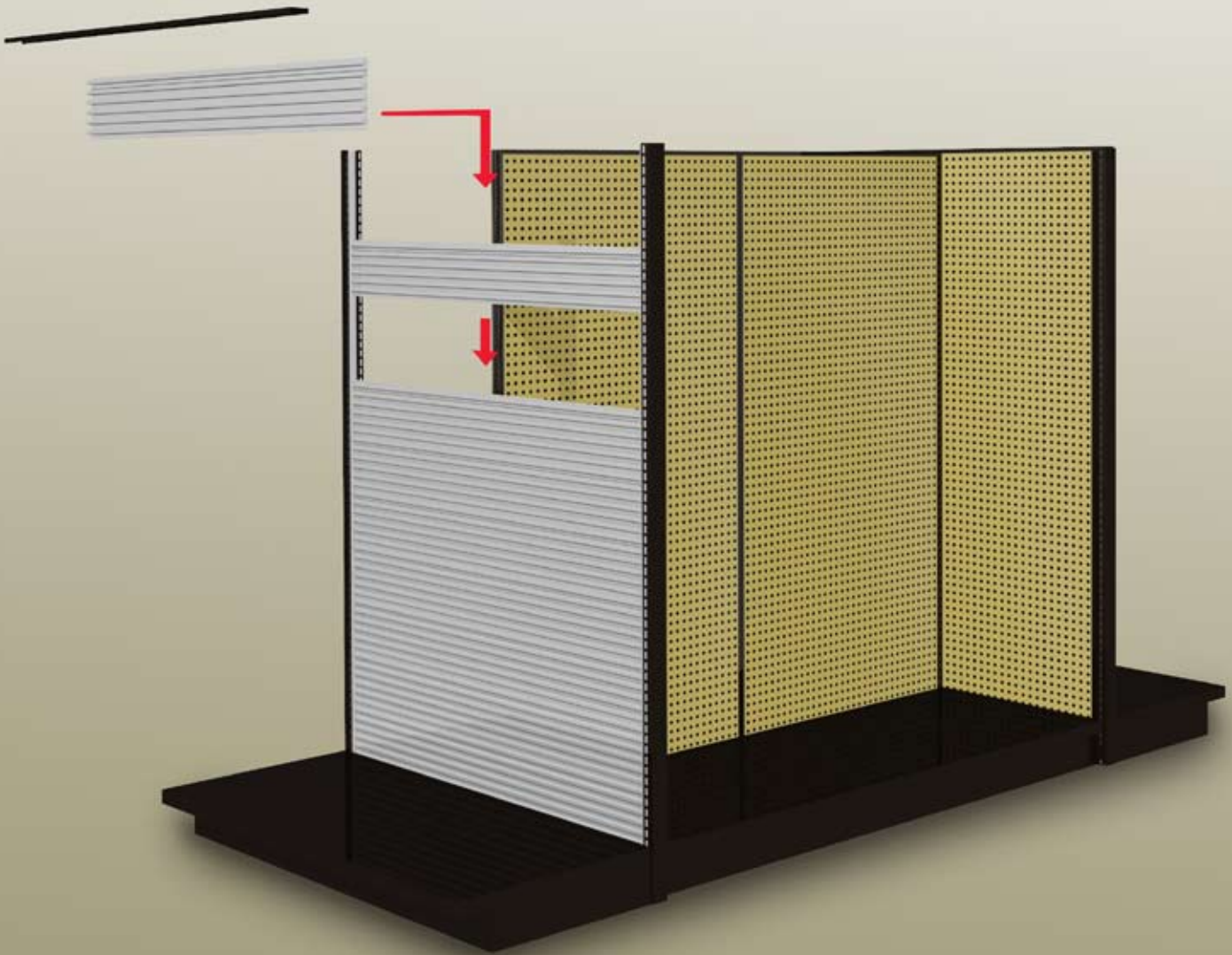

Make your old fixtures look new. Simple and affordable.

Call us with measurements of your existing gondolas or displays. We can design MegaWall panels to update nearly any gondola unit. Our solutions are easy, quick and effective at minimal cost. We can make tired old fixtures look great!

Our custom reducer channels fit most display units and provide a slide-in channel for MegaWall inserts.

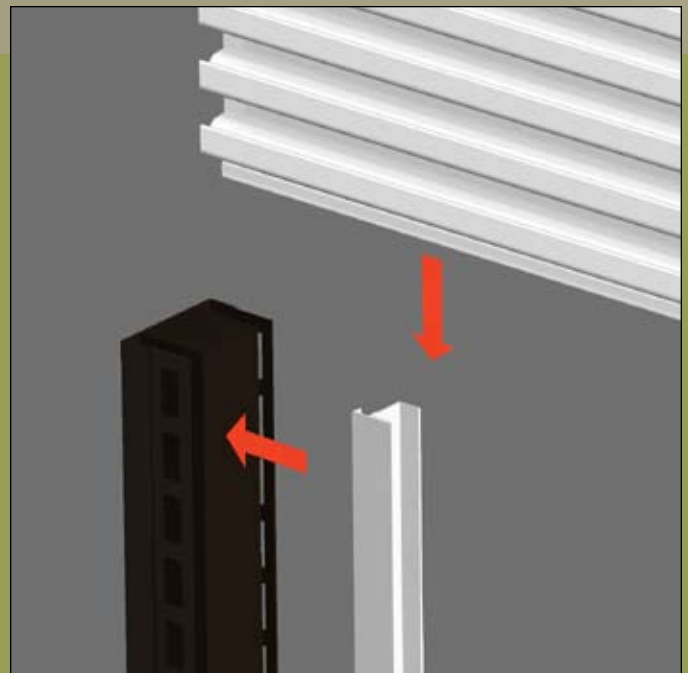

Custom display fixtures too.



We're eager to design or quote any project. Just call!

We have a great assortment of existing designs that can be delivered quickly. Gondolas, T-units, H-Units, rolling and modular displays - you name it and we do it. We also design & produce custom displays to customer needs. Have your own design in mind? Call us and we'll help make it happen.



MEGAWALL[®]
SLATWALL SYSTEMS
800-948-2736 www.megawall.com



Terms and Conditions

Payment and Terms

Terms are net 30 days from date of invoice (shipping date) to all approved accounts. All overdue accounts will be charged at a rate of 1-1/2% per month, calculated daily. American Express, Visa and Mastercard accepted.

Credit

Acceptance of orders and shipment shall be subject to the approval of our credit department. New accounts are asked to complete our "New Account Application" form with their order.

Shipments

All shipments are F.O.B. our plant, Comstock Park, Michigan. Where shipment is requested on a prepaid basis, the freight charges can be included on the invoice, or charged separately by prearranged third party billing or "collect" directly to the consignee.

Cancellations

Cancellations will not be accepted on any orders for custom or special items at any time after entry into our system. Cancellation requests for regular items will incur a \$50 charge to defray administrative costs after the order has been entered into our system.

Freight Claims

Claims for non-delivery, partial loss in transit, goods received in damaged condition, or other freight claims should be made by the purchaser immediately against the carrier involved. We ship on an F.O.B. basis, our liability ceases when the carrier accepts the goods.

Non-Conforming Shipments

Claims for short shipments must be made against MegaWall, Inc. within ten days of receipt of shipment.

Liability

We have no responsibility for consequential or incidental damages resulting from the purchase or use of the goods. Additionally, we will not be responsible for any delay in the performance of any order or in the delivery of any goods, or for any consequential or incidental damages resulting.



MEGAWALL[®]
SLATWALL SYSTEMS

MegaWall, Inc. 5340 Six Mile Court NW, Comstock Park, MI 49321

Phone 1-800-948-2736 Fax 616-647-4090

www.megawall.com